

NEST

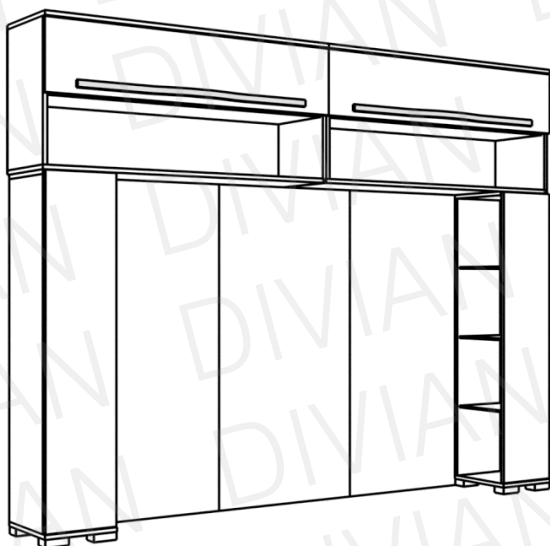

260 cm



340-393 cm

SZERELÉSI ÚTMUTATÓ

Szekrény csomag tartalma:



bútorösszehúzó M5x30 21db

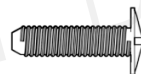

bútorösszehúzó M4x12 21db



tipli 8db



rúdtárcsa 6db



üvegpolc tartó 24db



kampó 4db



3,5x16 csavar 16db



3,5x16 csavar 24db



3,5x16 csavar 8db

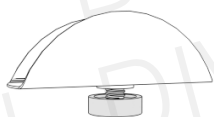

állítható láb
3 db



polctartó 16db

Szekrényelem rögzítő tartalma:



3,5x16 csavar 6db

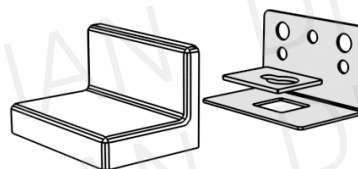

bútor akasztó
2 db



csavar
6 db

Szükséges szerszámok:

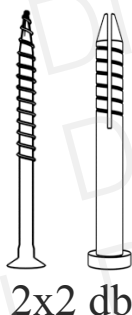

2x2 db

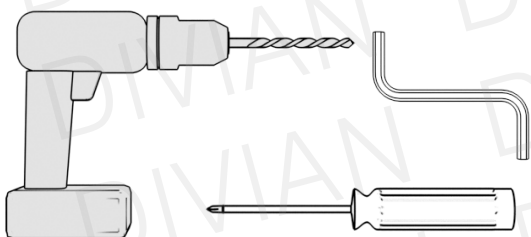

Ne egyedül végezze az összeállítást!

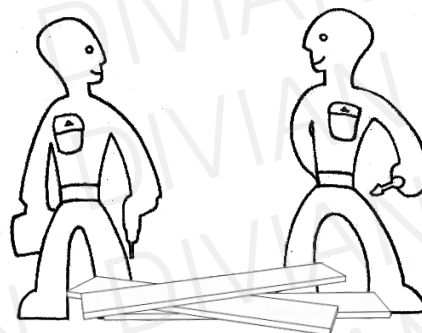

Óvja az elemeket a sérülésektől!

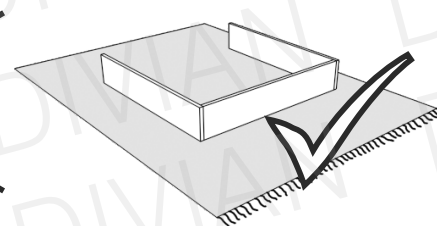
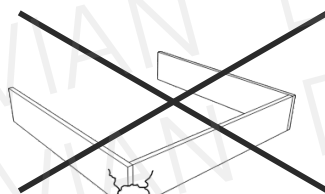

A csomagok több alkatrészt tartalmazhatnak, mint amennyire szüksége van!

ELEMEK

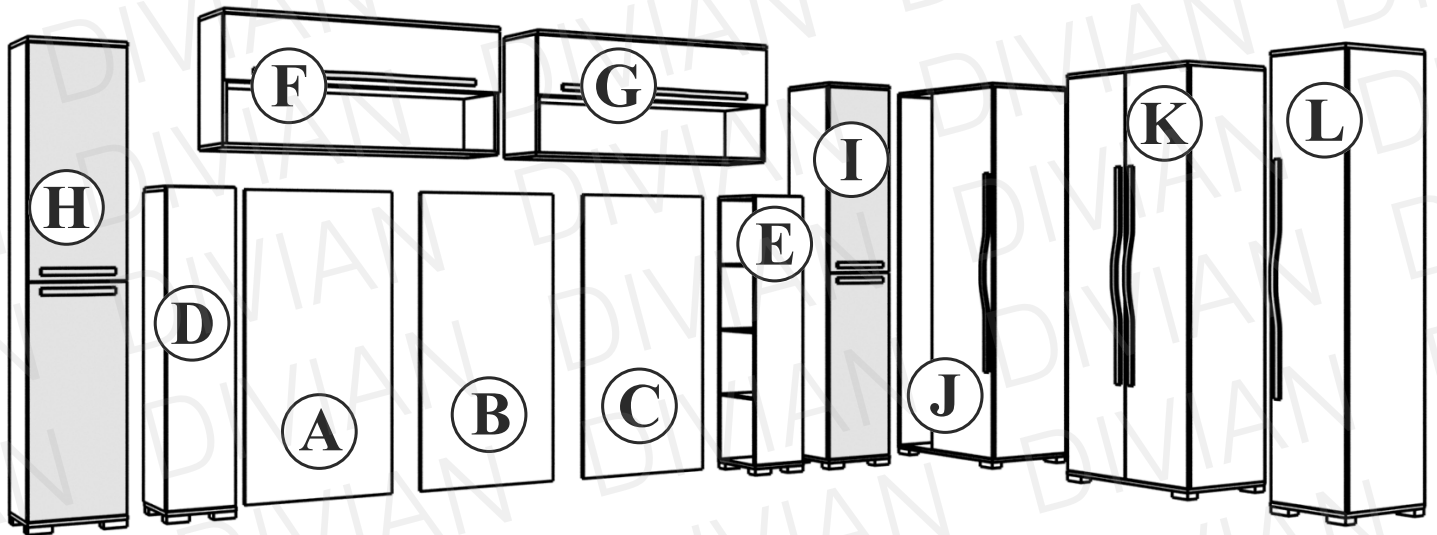

A könnyebb áttekinthetőség érdekében a szerelési útmutatóban az adott elemeket ajtók nélkül ábrázoljuk. Az összeszereléshez Önnek természetesen nem szükséges levennie az ajtókat!

i A 260 centiméteres sor esetén a szerelés a 7. pontnál ér véget.
340 centiméteres sor esetén a szerelés a 9. pontnál ér véget.

1

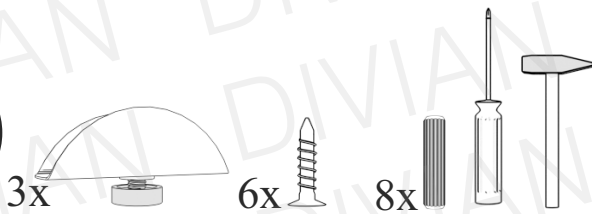

tiplik behelyezése

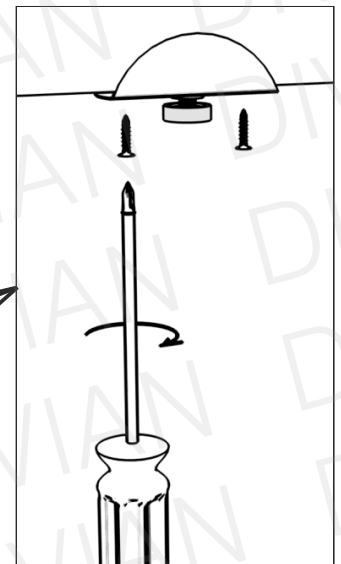
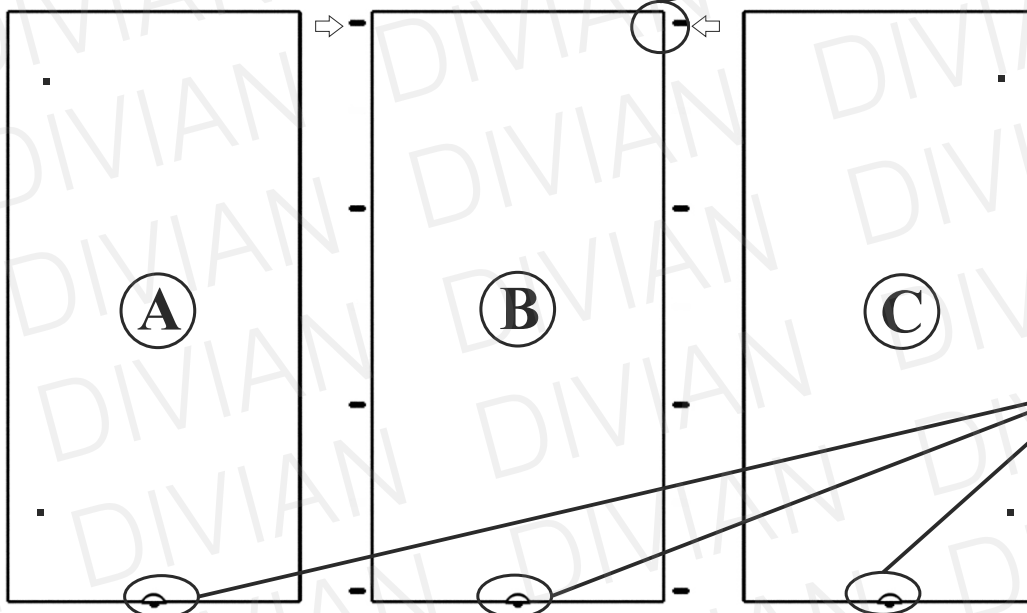
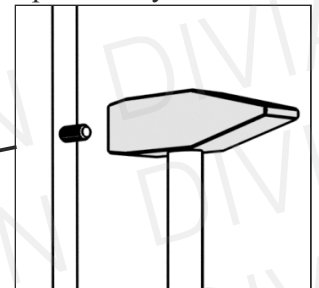

2

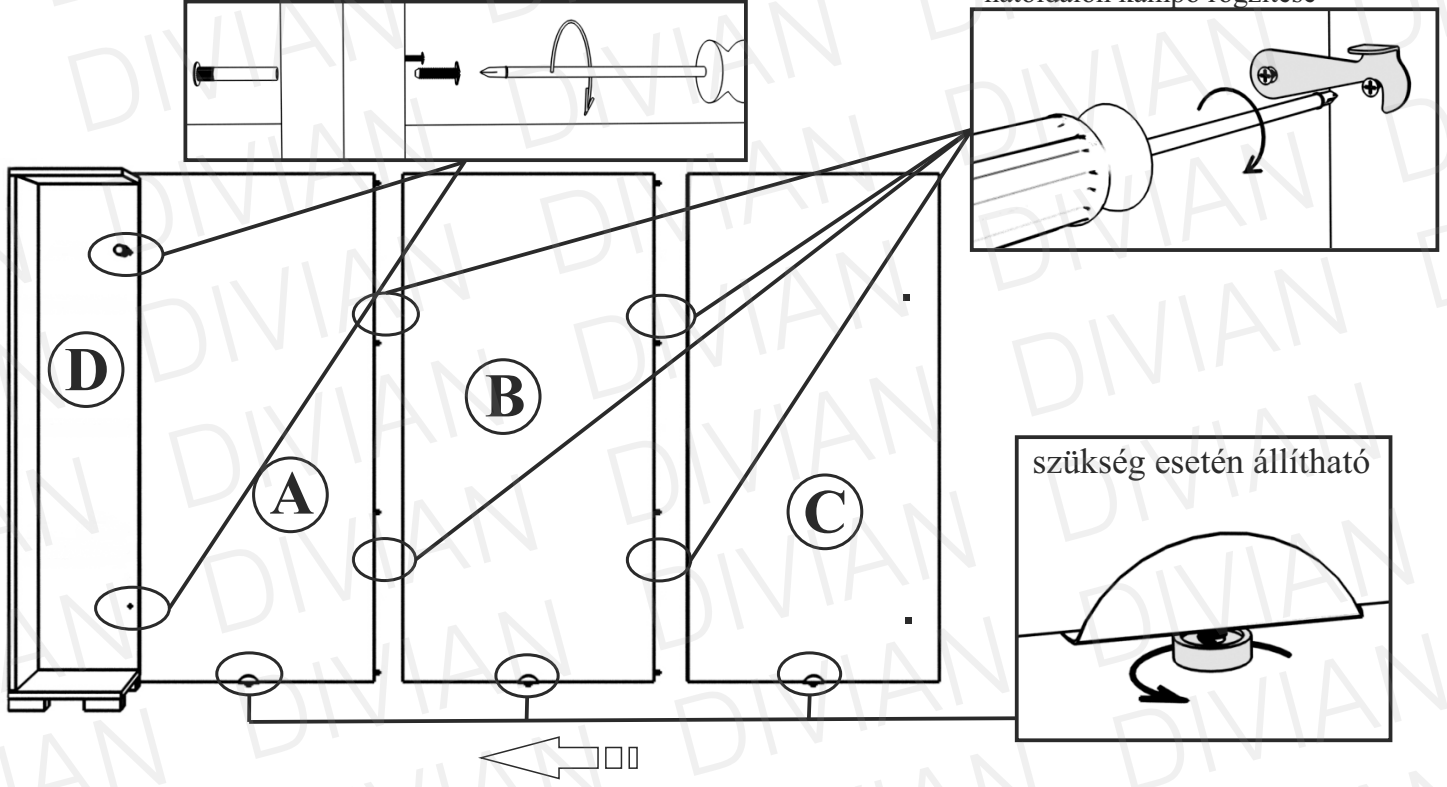
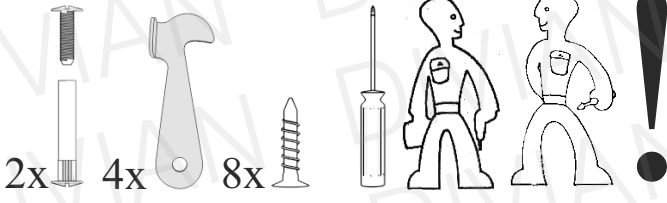

3

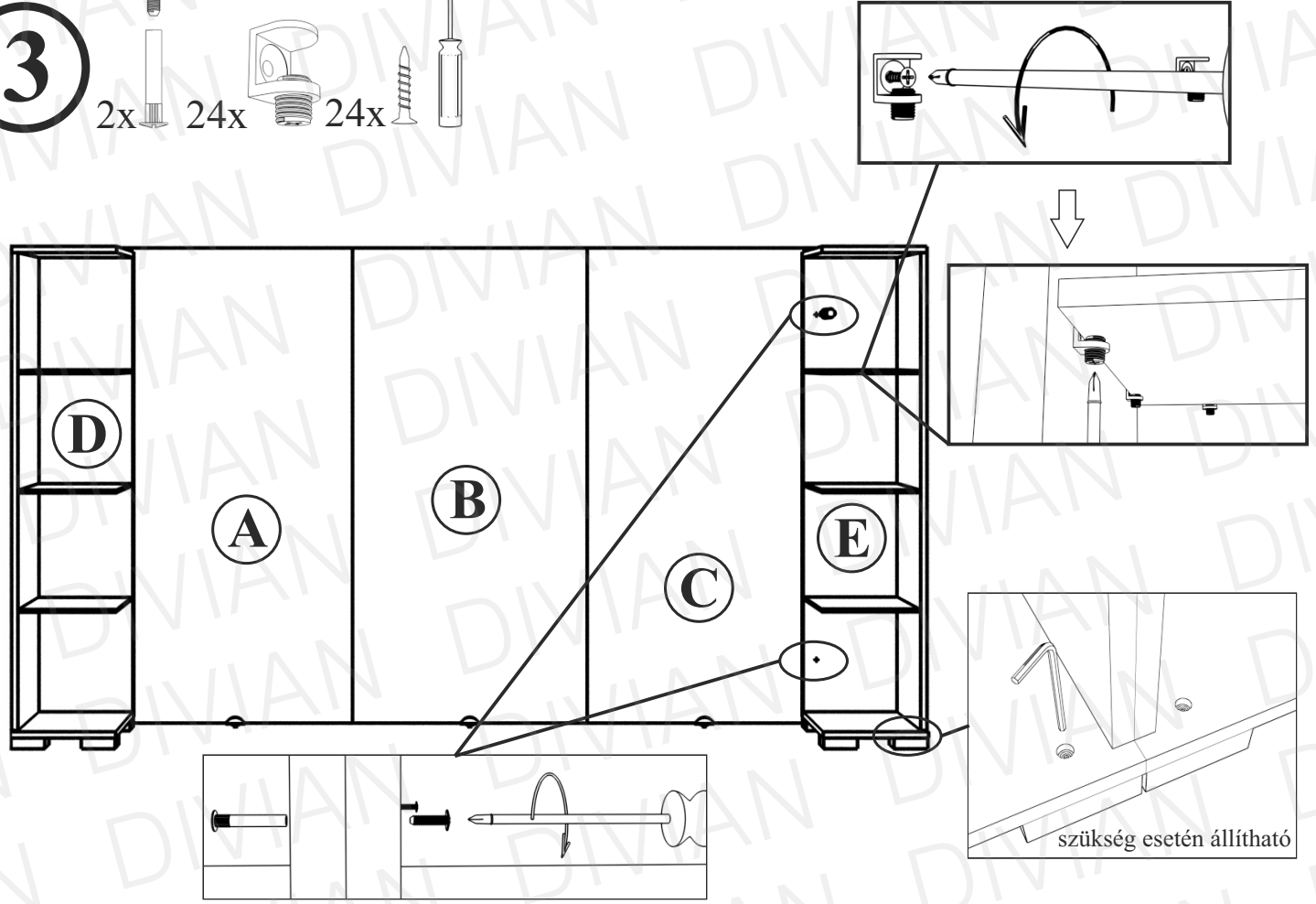
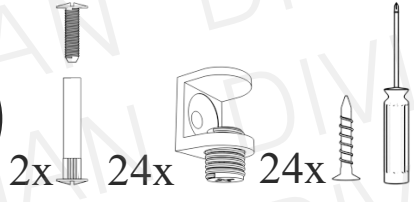

4

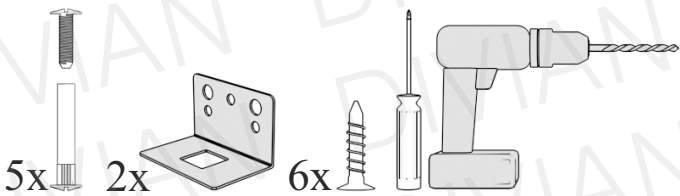

i F és G elem összeszerelése földön történjen!

i H és I elem hátfalát furja ki!

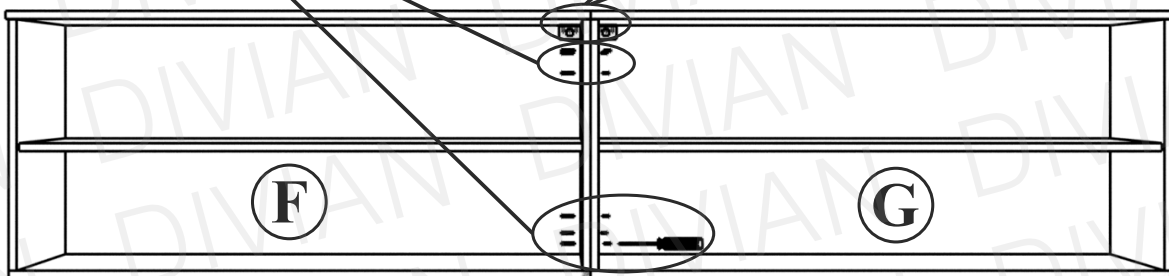
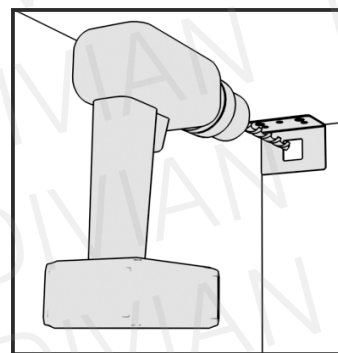
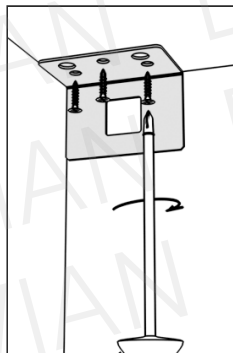
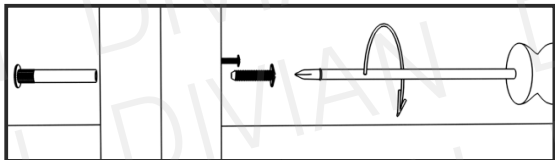

5

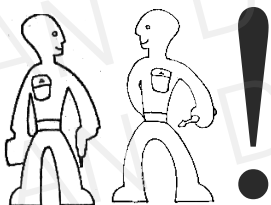

i F és G elemet emelje a helyére, jelölje ki a tipli helyét a mögöttes falon!

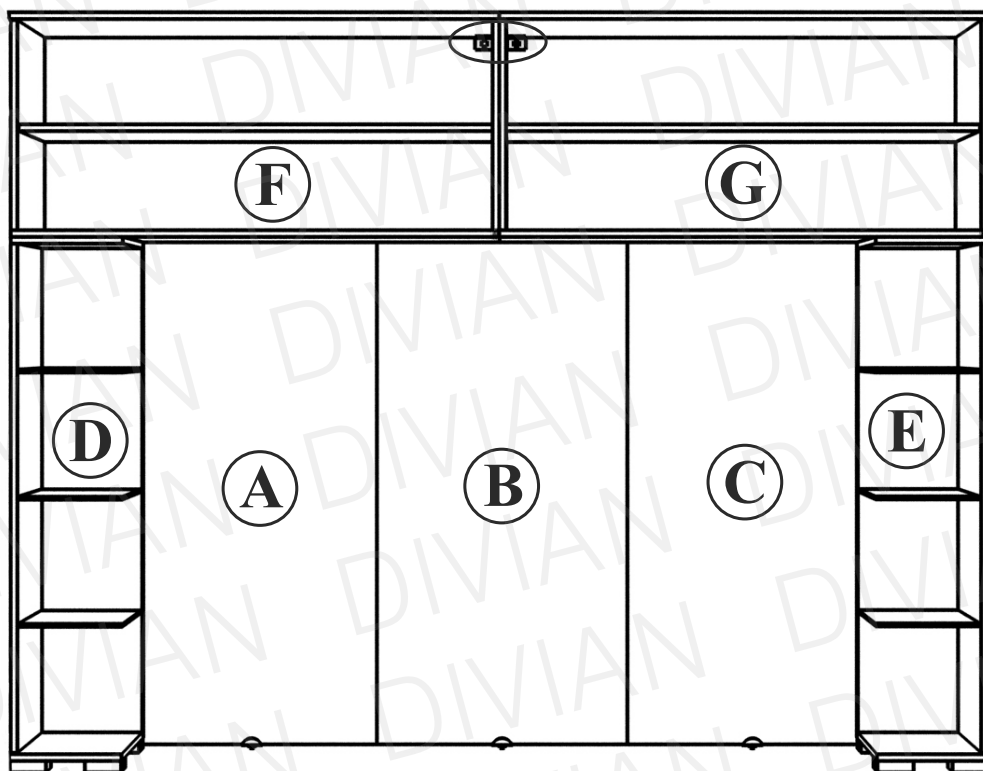

6

2x

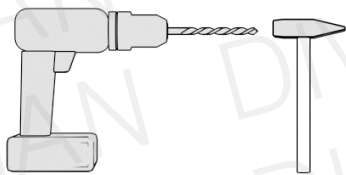

F és G elemet tegye a földre,
furja ki a bejelölt pontokat a falon!
Üsse be a tipliket!

++

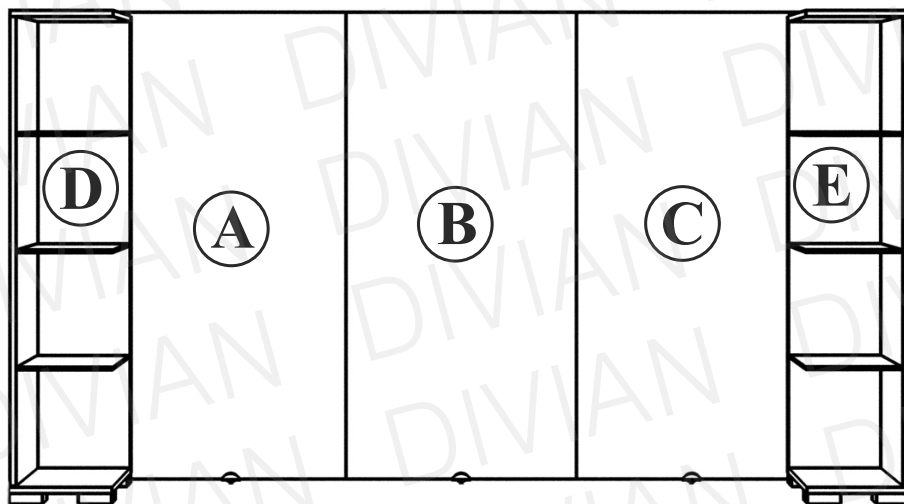

7

2x



2x

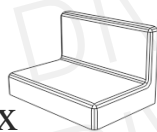

2x

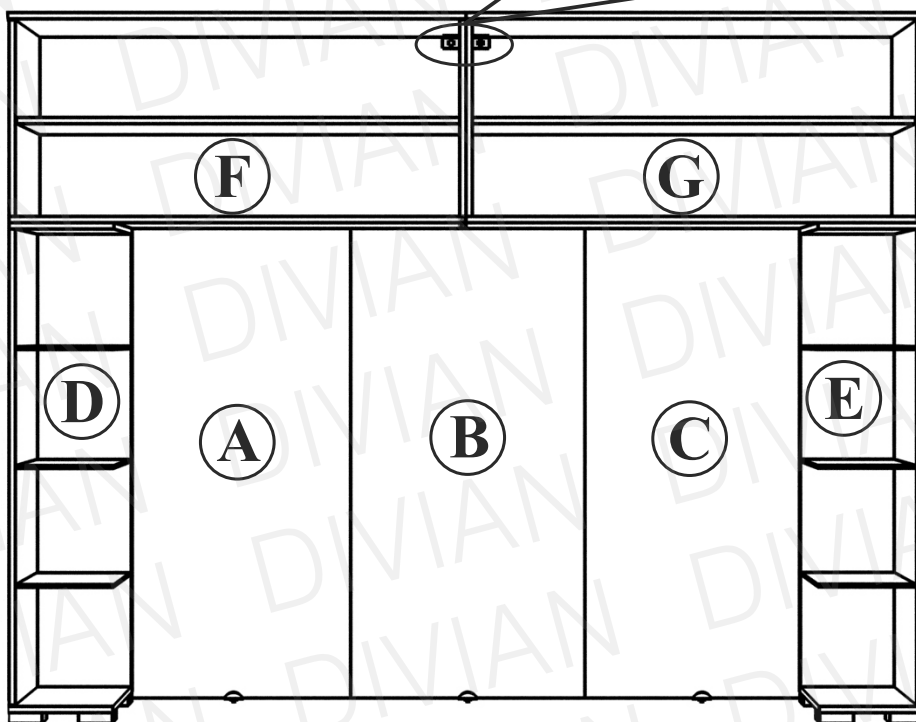
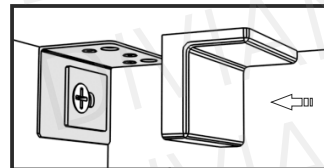
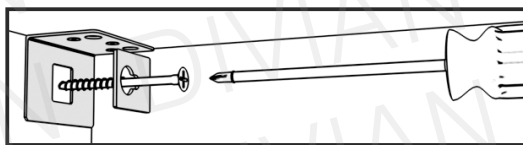
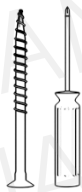

260 centiméteres sor ezzel a ponttal elkészült.

8

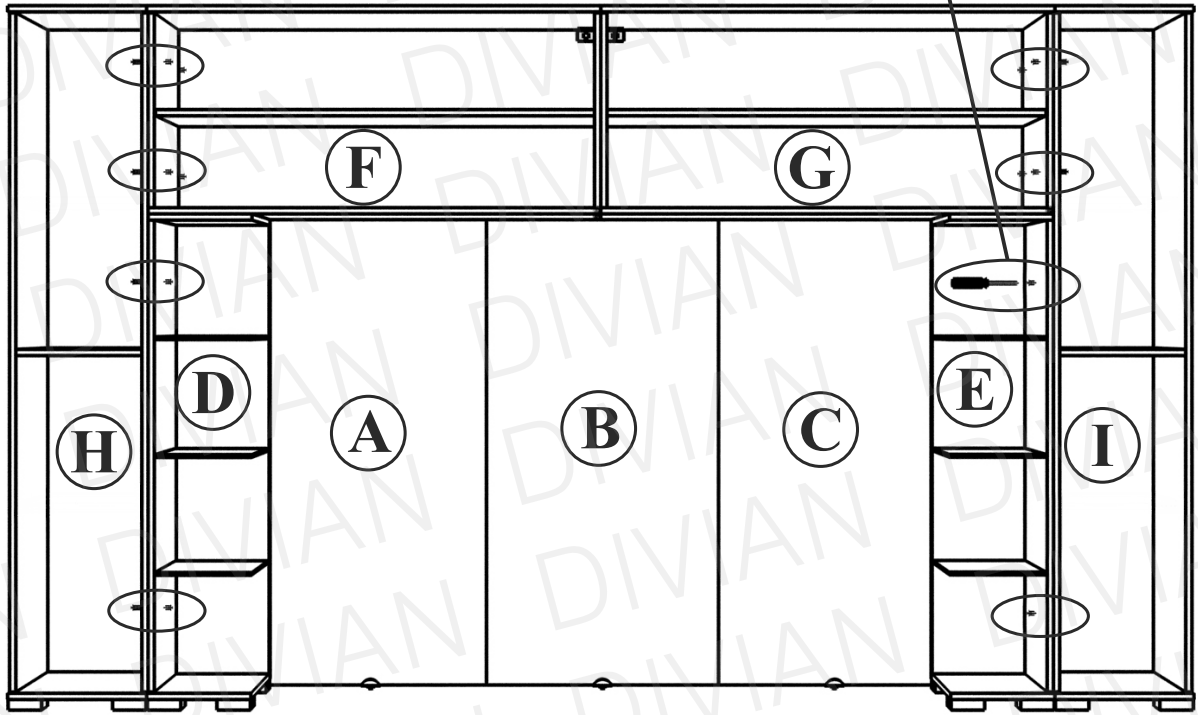
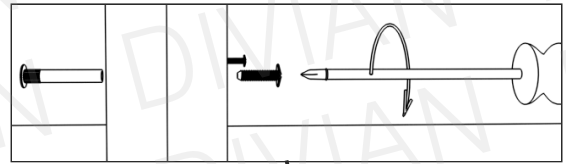
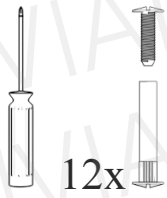

9

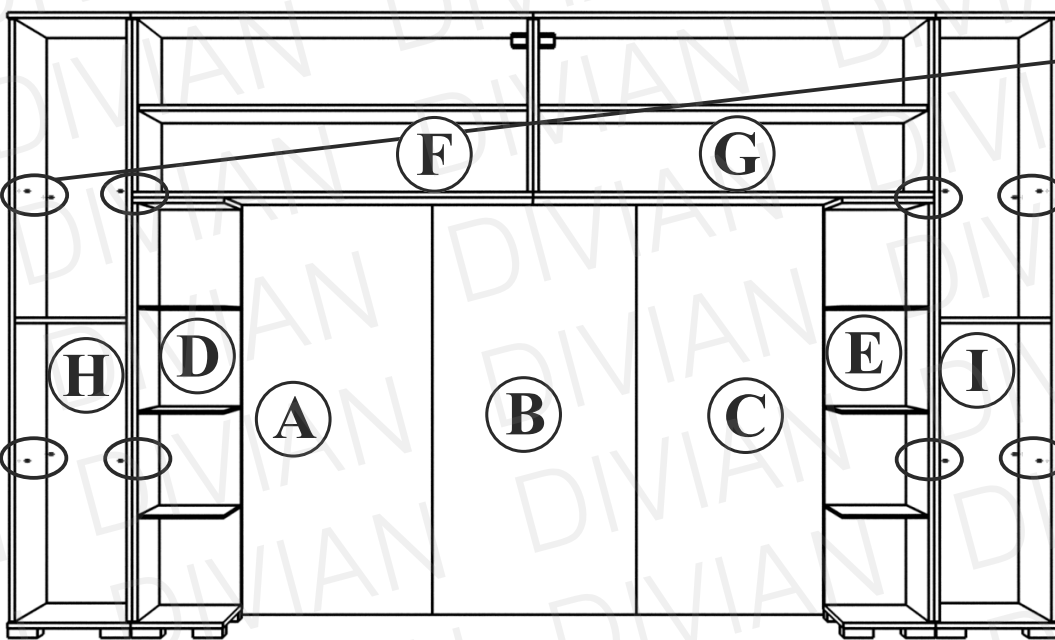
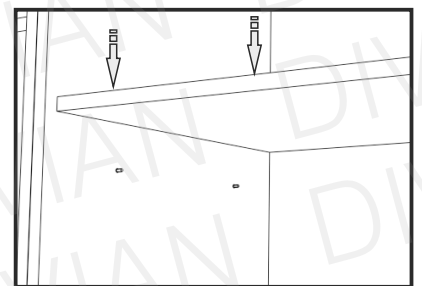
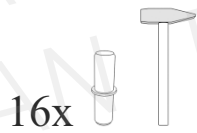

i

340 centiméteres sor ezzel a ponttal elkészült.

10**i**

J elem megfordításával, és a lábak/mánderlőrúd áthelyezésével, a garnitúra összeállítható jobbos és balos kivitelben egyaránt.

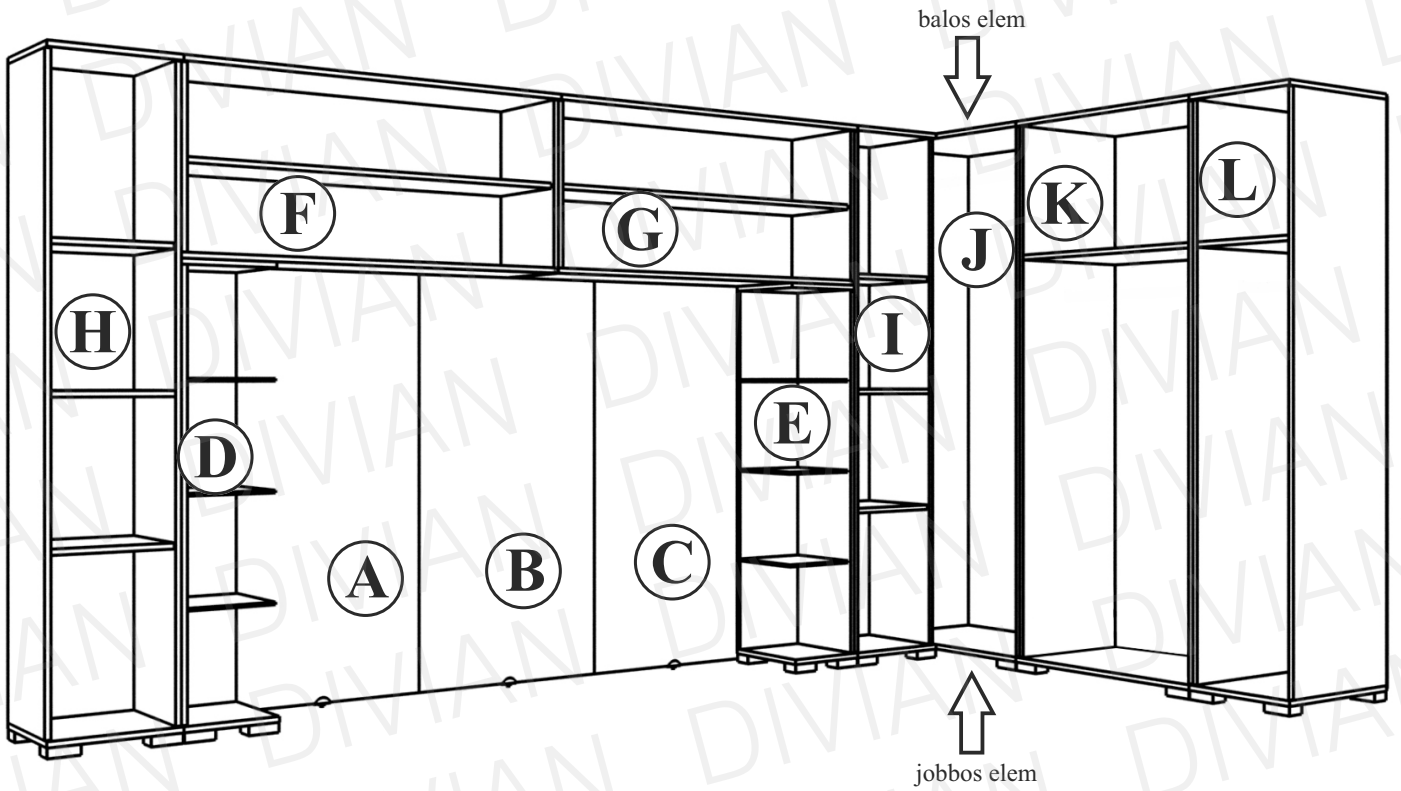
**11**

6x



12x

