

Gardrób

100 cm

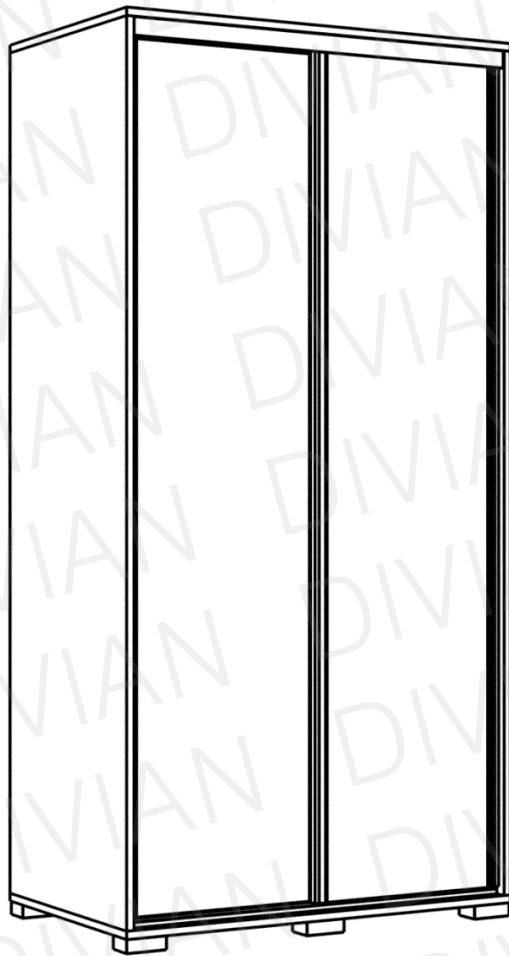

SZERELÉSI ÚTMUTATÓ

Tolóajtó csomag tartalma:

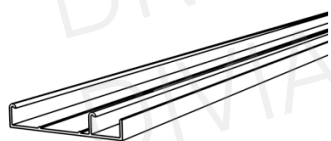

alsó sín 1db



6db

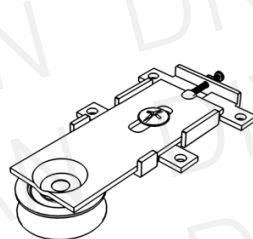

alsó görgő 4db



16db

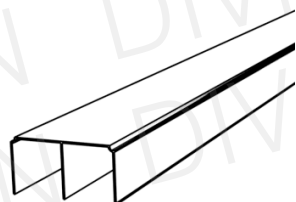

felső sín 1db

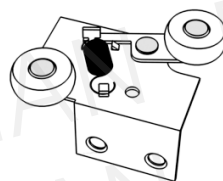

felső görgő 4db



12db

Gardrób csomag tartalma:



rúdtárcsa 4db



3,5x16 csavar 8db

Szükséges szerszámok:

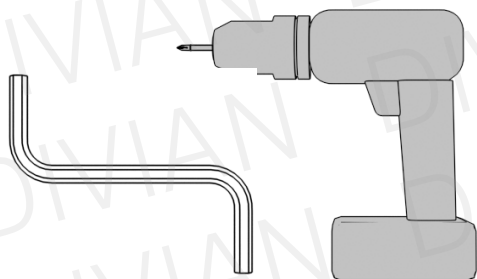

Ne egyedül végezze az összeállítást!

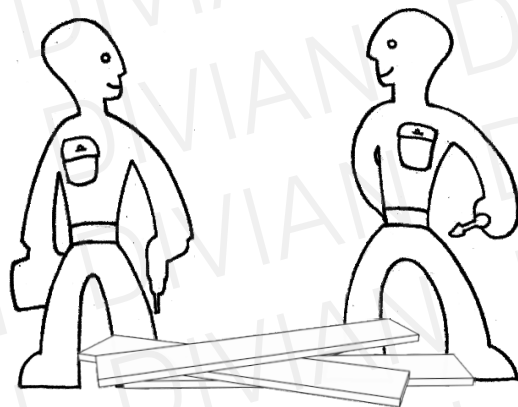

Óvja az elemeket a sérülésektől!

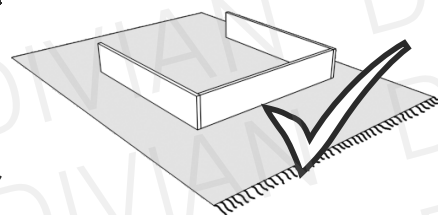
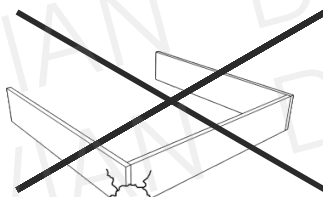

A csomagok több alkatrészt tartalmazhatnak, mint amennyire szüksége van!

1

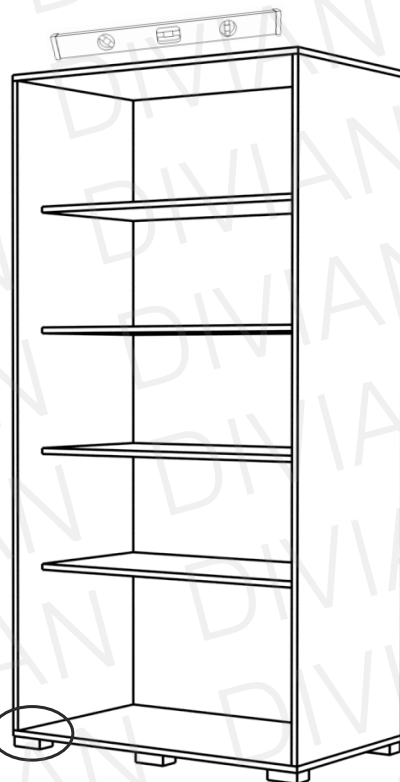
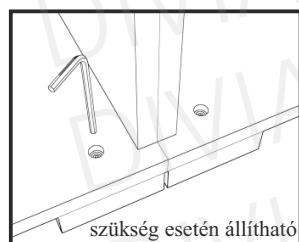
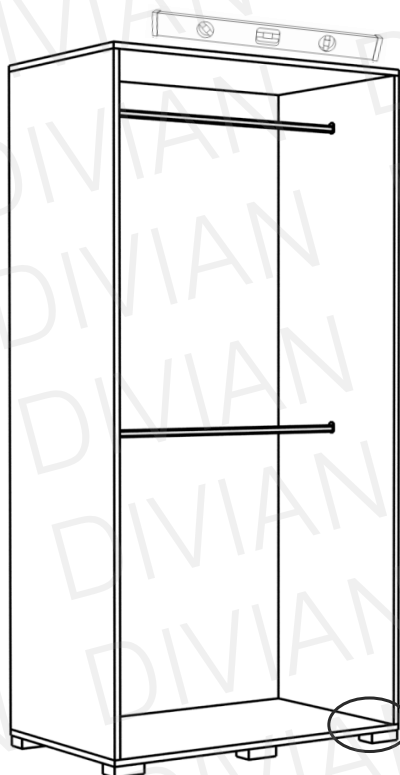

i Amennyiben polcos elrendezésben kérte a sarok elemet, akkor a polcokat még a szerelési útmutató követése előtt tegye a helyére.

2

4x
(Gardrób csomag)



8x

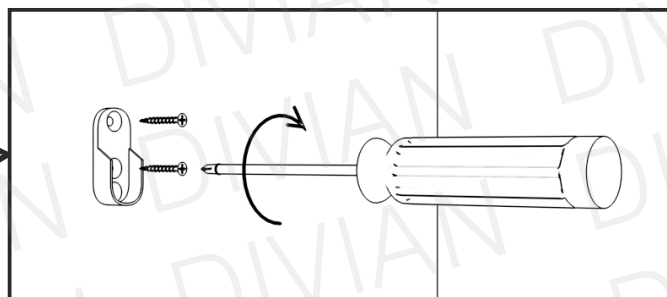
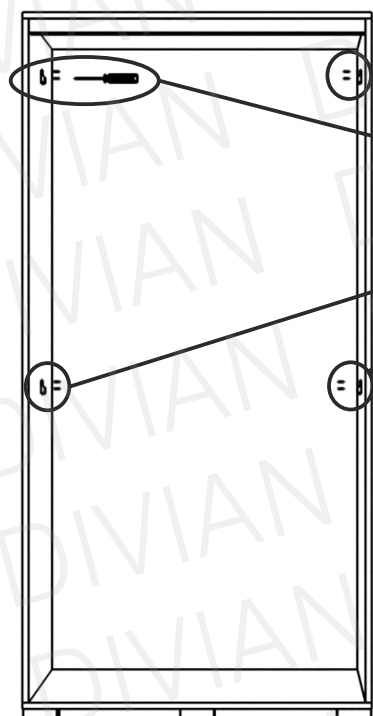

i Csúsztassa az akasztókba a mánkli rúdakat!

3

3

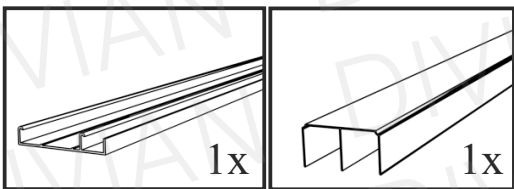

(Tolójtó csomag)

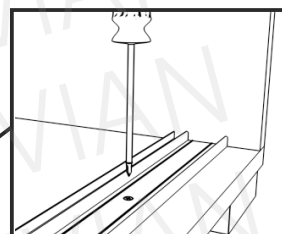
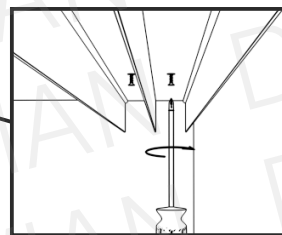
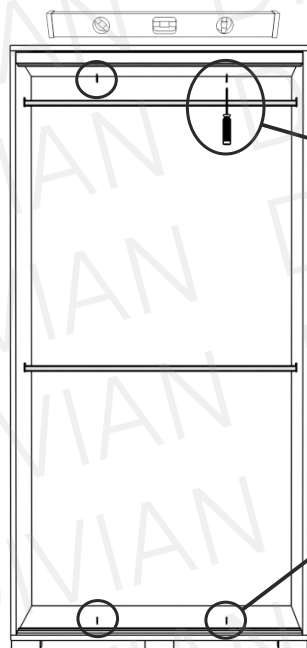
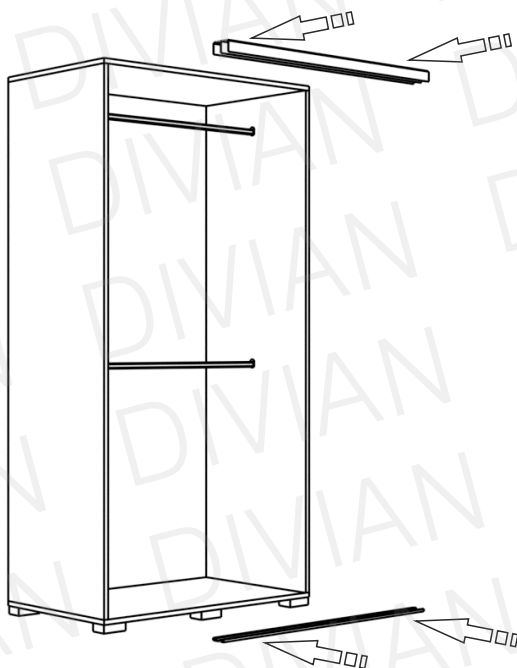
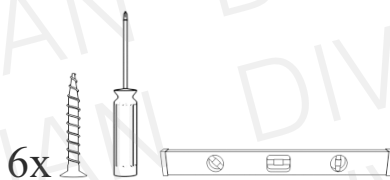

4

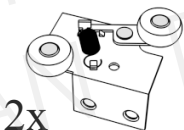

(Tolójtó csomag)

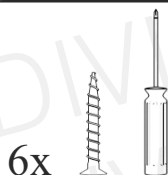

i

Ismételje meg az összes ajtón a műveleteket.

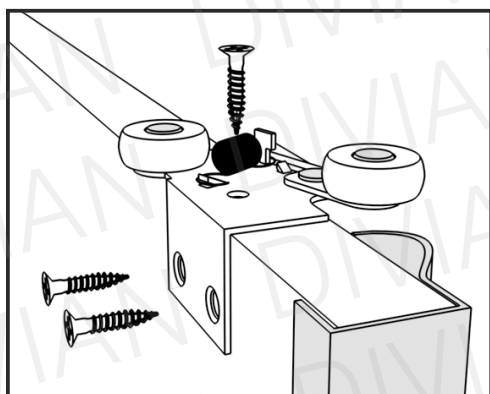

5

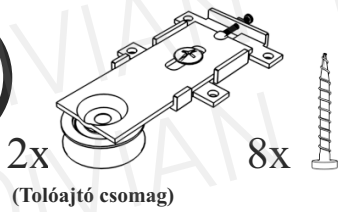

i

Ismételje meg az összes ajtón a műveleteket.

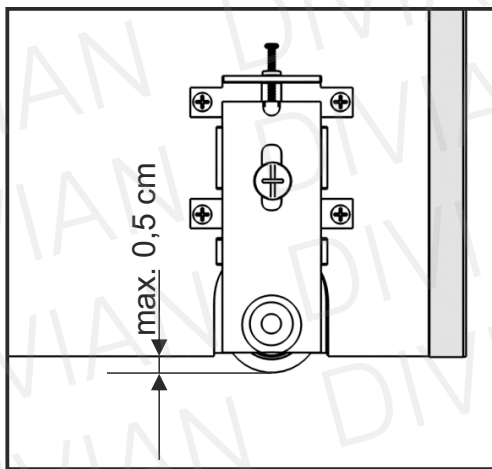
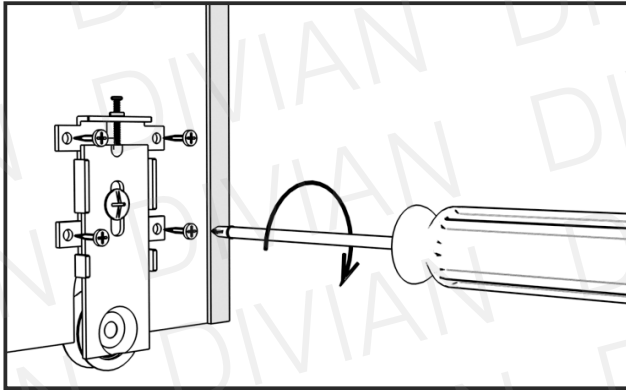

i

Alaphelyzetben a görgő maximum 0,5 centiméterrel lehet lentebb a bútorlapnál.

6

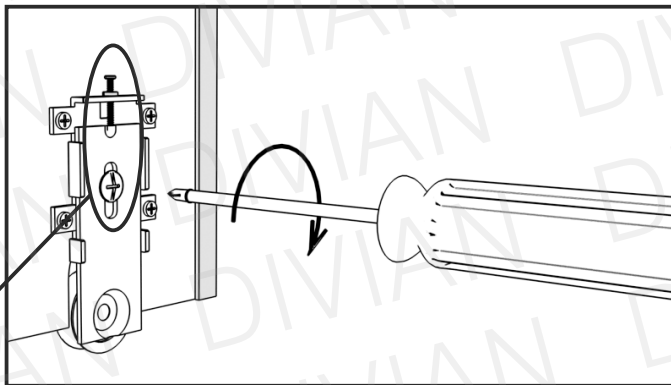

i

A görgő megfelelő helyzetét a felső és középső csavar segítségével állíthatja be. Fontos, hogy egy ajtón azonos beállítások legyenek! Az ajtók behelyezése után ezekkel a csavarokkal tudja pontosítani azok helyzetét, amennyiben azt szükségesnek látja. Továbbra is figyelve, hogy egy ajtón azonos beállítások legyenek!

7

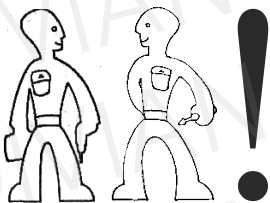

Illesse az ajtó felső részét a felső sínbe, tolja fel amennyire lehetséges, hogy függőleges helyzetbe állíthassa az ajtót. Majd engedje rá az alsó sínre. Ismétlje meg az összes ajtóval a műveletet!

